

 Roland®

JUNO-60

Owner's Manual

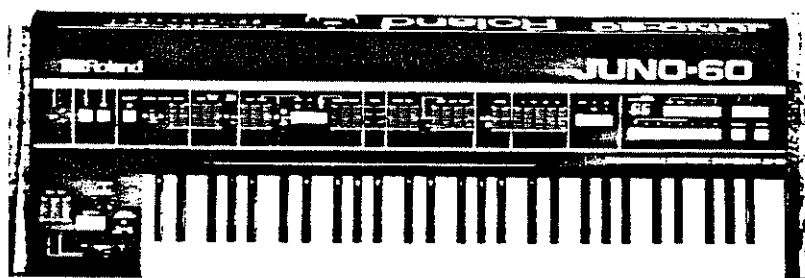

- The Roland Juno-60 is 61 key, 6 voice fully programmable polyphonic synthesizer.
 - The Juno-60 includes memory capacity to retain up to 56 different synthesizer patches. (8 patches x 7 banks)
 - Any program in memory can be temporarily edited during live performance.
 - The Juno-60 features battery back up system to retain the programs even when switched off.
 - The Tape Memory interface allows any patch programs to be saved into an ordinary tape recorder for storage and later retrieval.
 - If connecting the Pedal Switch to the PATCH SHIFT jack, you can call the 8 patch programs stored in the same bank one after another, simply by pressing the pedal.
 - The digitally controlled oscillator (DCO) guarantees an extremely stable pitch.
 - This is the complete 6 voice polyphonic synthesizer provided with 6 VCF's, 6 VCA's and 6 ENV's.
 - Wide variations of the Arpeggio Patterns are available by changing the MODE and RANGE switches.
 - The Chorus effect produces rich and expansive sounds.
 - Transposition to any key is possible by the Transpose function.
 - The Juno-60 can be driven by the MC-4 micro-composer by using its PCB connector.
 - ★ It is necessary for you to understand the functions of the controls and selectors of the Juno-60 perfectly to fully enjoy the advantages of the unit. Some setting examples are shown in this manual to make it easier for you to master how to operate the Juno-60, but you are the one who creates the sounds. Please find out your own setting and new ways of playing.
- < Important >
- Please do not turn the Power switch on immediately after turning it off; wait for a few seconds.

Contents

● Basic Connections	5	IV. Effects	22
● Functions	6	Chorus	22
I. Memory Functions	6	Other Effects (Optional)	22
Memory	6	● Arpeggio Sample	23
Tape Interface	9	● Sample Sounds	24
II. Functions for Sound Creating	12	● Sound Synthesis Memo	29
DCO	12	● Specifications	32
HPF	14	● Options	33
VCF	14		
VCA	16		
ENV	16		
LFO	17		
III. Functions for Playing	18		
Keyboard	18		
Controllers	18		
Arpeggio	19		
Hold	20		
Key Transpose	20		
Remote Controls	21		

Functions for Playing

KEY TRANSPOSE BUTTON

Hold this button down and press the key to which you want to transpose.

COLD SWITCH

The sound remains even after the key is released. (This applies to Arpeggio as well.)

POWER SWITCH

Turns on and off the Arpeggio function.

MODE SWITCH

Changes the movement of the patterns.

RANGE SWITCH

Change the pitch ranges.

RATE KNOB

Changes the rate of Arpeggio.

LFO

A Low Frequency Oscillator that generates vibrato and growl effects. It also generates three waveforms that are the sound source of the synthesizer.

HPF & VCF

The filter that cuts or emphasizes harmonics and consequently determines the tone color.

VCA

The amplifier that controls the amplitude, i.e. changes the volume.

ENV

It generates the control voltage which is applied to the VCA and VCF, controlling the harmonics and the volume.

Effect

Memory Functions

SAVE BUTTON

Press this button when saving the whole patch programs into a tape.

VERIFY BUTTON

Press this button when checking the recorded Data.

LOAD BUTTON

Press this button when sending the recorded Data back into the memory of the Jimo-60.

CHORUS MODE SWITCH

This changes the depth of the Chorus effect.

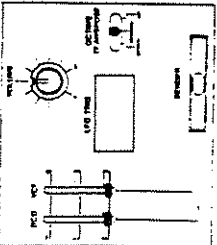
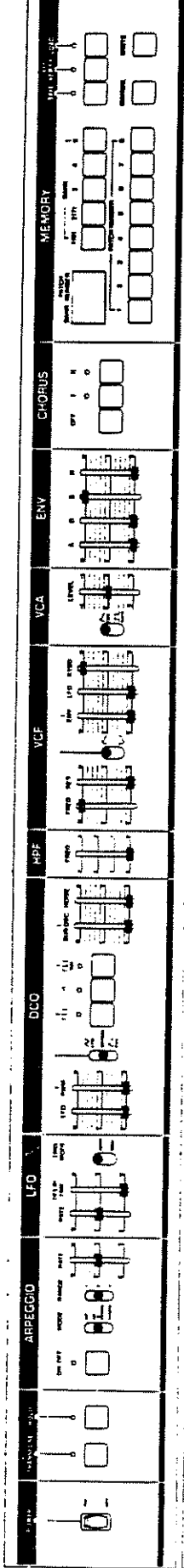

BAND KNOB

This control sets the maximum effect of the BENDER.

LFO TRIGGER BUTTON

The manually operated button for the LFO. (It works when the TRIGGER MODE switch, situated in the LFO, is set to MAN.)

BENDER KNOB

A manually operated lever which controls the pitch of the DCO and the Cutoff Frequency of the VCF.

VOLUME KNOB

This controls the rate of the LFO.

TRANSPOSE SWITCH

To alter the range of the keyboard. (It octave up and down.)

RATE KNOB

This controls the rate of the LFO.

DELAY TIME (Rate Time) knob

(AUTO) In this mode it delays the vibrato (growl) effects by the set amount. (MANUAL) While the LFO TRIGGER button is being pressed, the DELAY TIME determines the time required for the LFO signal to become maximum.

TRIGGER MODE SWITCH

The LFO operates either manually or automatically depending on which position this switch is set to. (MANUAL, AUTO)

LFO MODULATION KNOB

It adjusts the depth of the vibrato effect.

POLARITY MODULATION KNOB

The polarity width is adjusted. (LFO, ENV) The intensity of the modulation is controlled.

ENV MODE SWITCH

To select the pulse width controlling signal.

ENV FORM

You can select the output waveform of the DCO. (Each of them can be switched on and off individually.)

SUB OSCILLATOR LEVEL KNOB

This is the volume knob for another sound source, NOISE.

HPE CUTOFF FREQUENCY KNOB

As you raise the knob, low frequency harmonics are cut off. (The sound is getting brighter.)

RESONANCE KNOB

This emphasizes the Cutoff Point, (creating unusual sounds.)

POLARITY SWITCH

This determines the polarity of the Envelope. (Negative polarity is for special effect.)

ENV MODULATION KNOB

This adjusts the level of the ENV signal which controls the Cutoff Point of the VCF.

LFO MODULATION KNOB

This adjusts the depth of the growl/vibrato effects.

KEY BELLOW KNOB

As you lower the knob, the difference of the tone colors between different notes becomes larger.

CONTROL SIGNAL SELECTOR SWITCH

This selects the signal which controls the VCA. (It decides whether to change the volume by using ENV signal or Gate signal.)

VCA LEVEL KNOB

This controls the time needed for the voltage level after this key is pressed.

DECAY TIME KNOB

This determines the time needed for the voltage to reach the Sustain level.

SUSTAIN LEVEL KNOB

This determines the Sustain level to which the voltage falls at the end of the Decay time.

RELEASE TIME KNOB

This sets the time required for the sound to finally fade out after the key is released.

PROGRAM NUMBER DISPLAY WINDOW

This is where the BANK/PATCH number, Manual mode (M) or error (E) are indicated.

PATCH NUMBER BUTTON

These buttons are to select the patch number where a patch program is to be written.

BANK BUTTON

These buttons are to select the bank where a patch program is to be written.

MANUAL BUTTON

Press this button when synthesizing without using a Patch Program at all.

WRITE BUTTON

Press this button when storing a patch program into memory.

Functions for Sound Creating

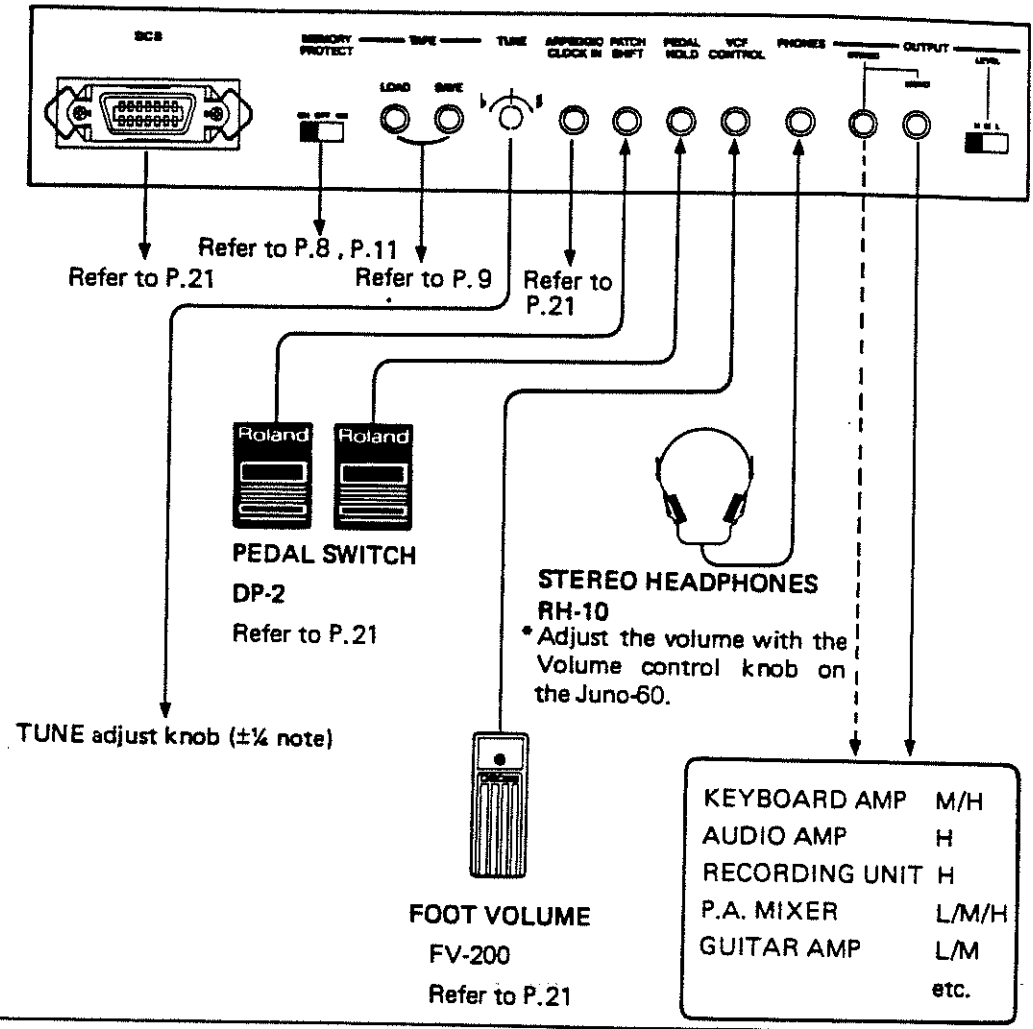

The Juno-60 includes enough memory capacity to retain up to 56 different patch programs which you can change from one to another during live performance just by flick of a button.

Also, you can edit any patch program in use by moving the controls. It also features battery back-up circuit to retain the programs even when switched off.

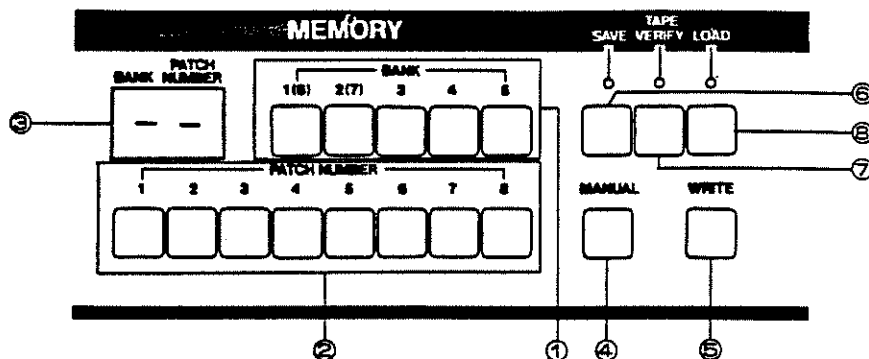

- ① BANK buttons
- ② PATCH NUMBER buttons
- ③ Program Number Display window
- ④ MANUAL button
- ⑤ WRITE button

<Tape Interface>

- ⑥ SAVE button & indicator
- ⑦ VERIFY button & indicator
- ⑧ LOAD button & indicator

(a) Selecting

You can select a patch from memory by using a BANK button ① and a PATCH NUMBER button ②. In this case, you may push either the BANK button or PATCH NUMBER button first. Also, you can change only BANK NUMBER or PATCH NUMBER. If you wish to choose Bank ⑥ or ⑦, hold the Bank button ⑤ down, and press ① or ②.

- * The selected Program number is shown in the Program Number Display window ③.
- * All 56 patches are user programmable, but are pre-programmed to provide you with examples and programs ready to be used. (Refer to P. 24)

► Example

● 23 (Bank: 2, Patch: 3)

● 71 (Bank: 7, Patch: 1)

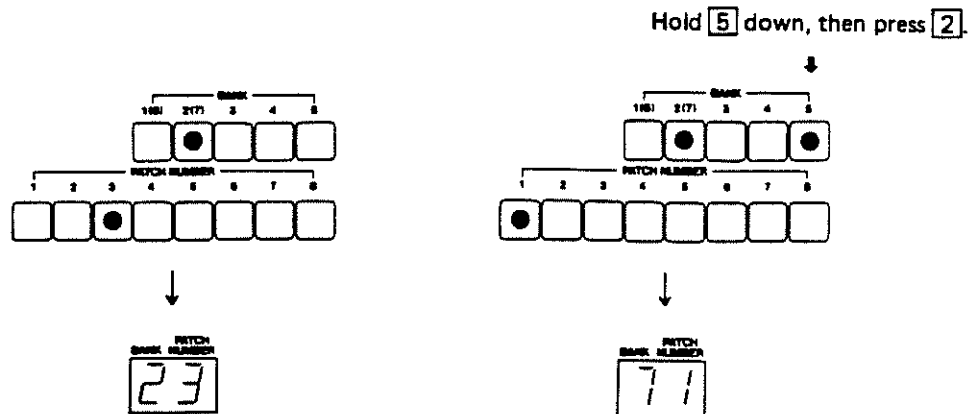

(b) Editing

You can edit any patch program in use as you play. If you move a desired control even slightly, its setting position of that patch program will be deleted and ready to be manually controlled. As soon as you start editing, the two dots in the Program Number Display window will light, showing that the Juno-60 is in Edit mode.

* This Editing function may be used as a real time performance control since it does not automatically rewrite the existing program, unless the appropriate operation for rewriting is done. (Refer to P. 6) Therefore, selecting the same patch program later, you will hear the original tone color unchanged.

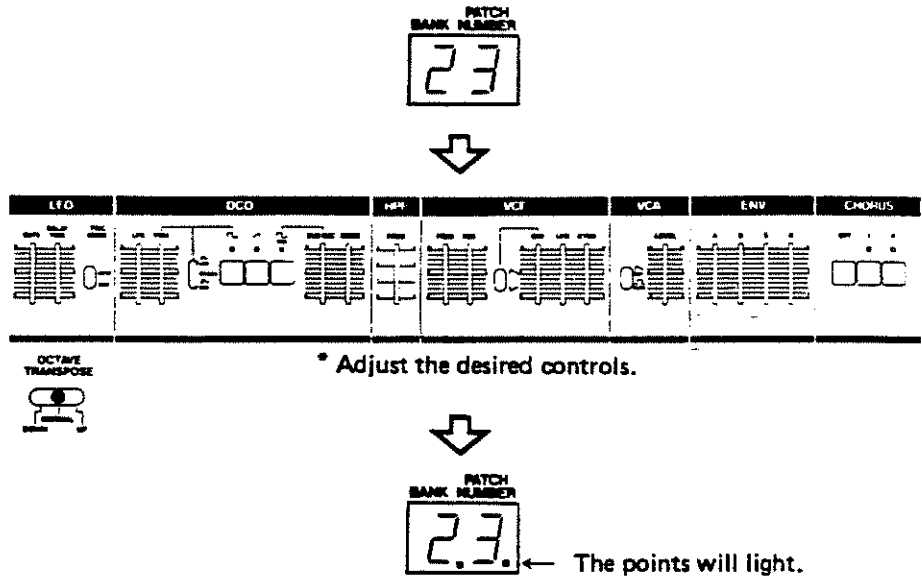

* Editing does not affect the original patch program.

(c) Writing

You can write a new patch or an Edit (b) into memory. The settings of the knobs (covered red) and the position of the OCTAVE TRANSPOSE switch are memorized as a patch program. (Refer to the diagram below).

* The old patch program previously stored is automatically deleted when you have completed writing a new patch.

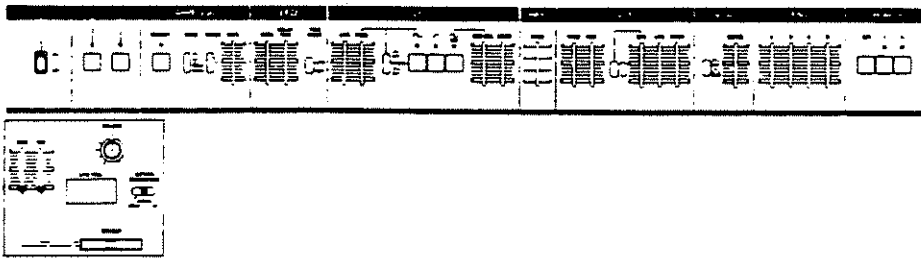

► Operation

1. Press the MANUAL button and set the controls as you like. Otherwise, select a patch program by BANK and PATCH NUMBER buttons and edit its tone color.
2. Set the MEMORY PROTECT switch on the rear panel to OFF.
3. Press the WRITE button ⑤.
4. While holding the WRITE button down, press a BANK and a PATCH NUMBER buttons.

Now you have correctly written a patch program into memory.

5. Set the MEMORY PROTECT switch to ON.
- * When writing an Edit, press the same BANK and PATCH NUMBER buttons, and the original patch program will be replaced with the Edit. If you press a different BANK and PATCH NUMBER buttons, both the initial patch and the edited patch will be retained.

Sound Synthesizing

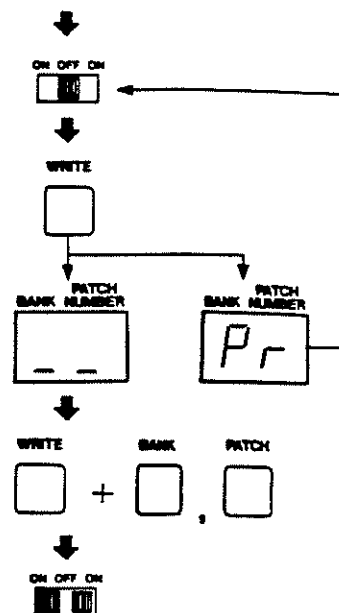

- * The Juno-60 features battery back-up system to retain the programs even when switched off. The batteries should be replaced with a new set in every five years. In this case, please have your local Roland dealer replace the batteries. (The first replacement might be required before five years.)

(d) Copy function

This copy function allows the user to copy any patch program and arrange the program numbers. There may be some patch programs which are more often used than others. If these patches are collected in the same bank, it will be easier to decide where to write a new patch, which after all save a great deal of work and time.

- * This function is particularly useful when the Patch Shift function (Refer to P. 21) is being used.

► Copying a patch from 23 to 17.

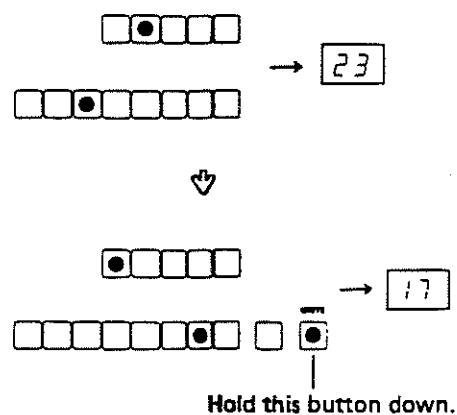

<Tape Interface>

The Juno-60 features the Tape Interface system which allows its patch programs to be saved into an ordinary tape recorder. Therefore, countless tone colors can be ready to be used.

► Connections

■ SAVE

———— TAPE ————

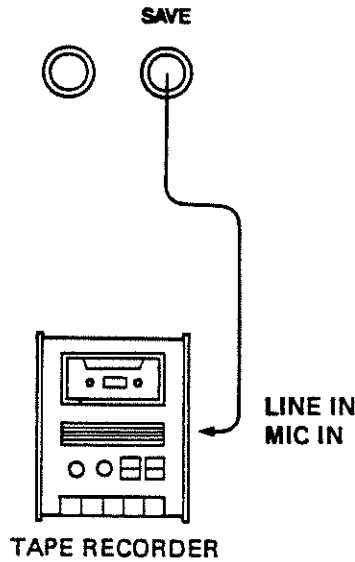

■ VERIFY, LOAD

———— TAPE ————

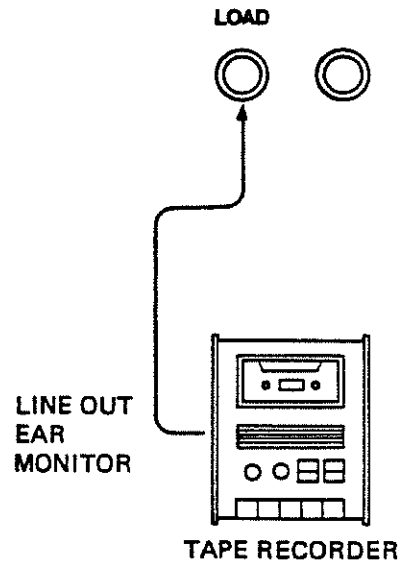

► Operations

■ Saving (the patch program into a tape recorder)

1. Set the tape recorder to REC (recording mode).

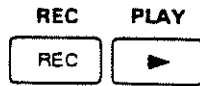

2. Press the SAVE button ⑥ of the Juno-60.



- The SAVE indicator will light up and the program number shown in the Display window will go out. Also, the Pilot tone will be sent from the SAVE jack.

3. If your tape recorder features the recording volume adjust knob, adjust it so that the Pilot tone registers near 0 dB.

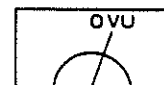

- In 4 or 5 seconds the Juno-60 produces a Modulated tone, i.e. saving into a tape recorder begins. (Be sure to complete adjusting the recording level before the Modulated tone is heard.)

- If the SAVE indicator goes out and the Program Number Display window shows double dash (--) (Manual mode), saving is completed. (All this takes approx. 50 sec.)



- If you wish to stop saving in the middle, press the MANUAL button (4).



■ Verifying

1. Set the tape so that it will be played back from the very beginning of the recorded Data (where you hear a Pilot tone).
 - If you use a tape recorder with the play back volume, set it to about a medium level.
2. Set the tape recorder to PLAY (playing mode) and press the VERIFY button (7) of the Juno-60.
 - If you wish to stop verifying in the middle, press the MANUAL button (4) of the Juno-60.
3. Stop the tape recorder.

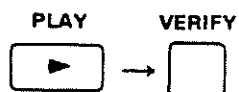

- The VERIFY indicator lights up and the Program Number Display window will go out, i.e. the recorded Data will be sent back and its accuracy will be checked.
 - Press the VERIFY button before the Modulated tone is heard.
- If the VERIFY indicator goes out and the Program Number Display window shows the double dashes (--), verifying is completed. (All this takes approx. 50 sec.)
 - If there is an error in your recorded Data, the Program Number Display window will show Er (Error).

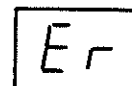

★ If there is an error . . .

Repeat the Verify procedure taking care of the following points.

- (1) Be sure to press the VERIFY button while the Pilot tone is heard.
- (2) Be sure to adjust the play back level of the tape recorder.
- (3) Check if connections are made correctly.

If there was an error in the very beginning of the Verify procedure, particularly take care of (1). If the Verify procedure did not complete even after 1 minute, (2), (3) are particularly required.

- If the above procedures were all correctly done, it is likely that there is something wrong with the tape.

★ If the error (Er) is again indicated . . .

Carefully repeat the Save procedure.

★ If the error is indicated again and again no matter how many times you try . . .

- Replace with a new tape.
- Clean and demagnetize the head of the tape.
- Use a different tape recorder and repeat the same procedure again.

★ Preserving the Data Tape . . .

Please do not keep the Data recorded tape in a place of high temperature or humidity or near a strong magnetic unit such as a speaker or an amplifier.

■ Loading (Sending the recorded Data back to the Juno-60)

1. Set the tape so that it will be played back from the very beginning of the Data (where you hear a Pilot tone).
2. Set the MEMORY PROTECT switch on the rear panel of the Juno-60 to OFF.



3. Set the tape recorder to PLAY (play mode), then press the LOAD button (B) of the Juno-60.

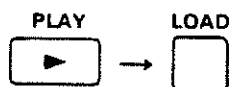

- The LOAD indicator will light up and the Program Number Display window becomes blank, showing that loading the Data has started.
- Be sure to press the LOAD button before the Modulated tone is heard.

- If the LOAD indicator goes out and the Program Number Display window shows double dashes (—), the Loading is completed.

- If you wish to stop Loading in the middle, press the MANUAL button (4).

4. When the Loading is completed, set the MEMORY PROTECT switch to ON and stop the tape recorder.



★ If there is an error . . .

Carefully repeat the Load procedure.

Be sure to set the play back level of the tape recorder to an appropriate level and press the LOAD button at the right moment.

DCO (Digitally Controlled Oscillator)

DCO is the digitally controlled oscillator that controls the pitch and creates three types of waveforms which are the sound source of the synthesizer. Compared to VCO (Voltage Controlled Oscillator), DCO has superior stability. The operations and functions of

the DCO are virtually the same as those of the VCO. A DCO does not, however, provide portament function, because of its digitally controlled system.

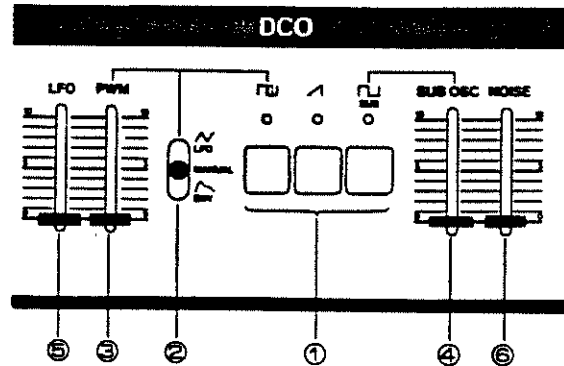

① **WAVEFORMS**

You can select the output waveform of the DCO. Each switch can be individually turned on and off and can be used with other switches.

<Pulse Wave>

When the top and bottom portions of the square wave are unequal, the result is what is called a pulse wave. The harmonic content of the pulse wave will depend greatly on the width of the pulses. It is possible to modulate, or change the pulse width by means of the LFO or the envelope generator.

② **PWM Mode switch**

When it is set to MAN, pulse width can be fixed. When it is set to LFO or ENV, pulse width is controlled by the corresponding signal from the LFO or the Envelope Generator.

③ **PWM • Pulse Width Modulation knob**

When PWM Mode switch ② is set to MAN, this knob controls the pulse width, and controls the intensity of the modulation when it is set to LFO or ENV.

④ **SUB OSC • Sub Oscillator Level knob**

It controls the volume of the SUB OSC.









⑤ **LFO • LFO Modulation knob**

It adjusts the depth of the vibrato effect when the LFO is controlling the pitch of the DCO.

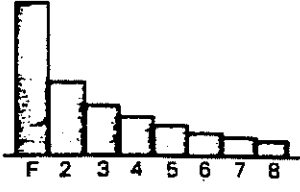
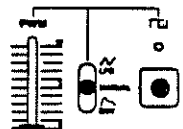
⑥ **NOISE • NOISE level knob**

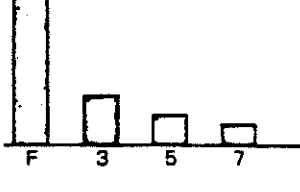
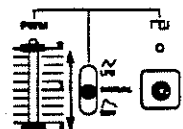
It controls the volume of the NOISE.

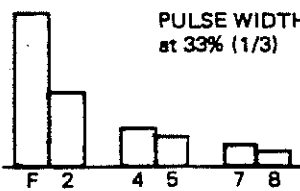
Waveform

Setting	Waveform	Description	Harmonic Content
	 Saw Tooth	The sawtooth wave contains a fundamental sine wave and its integral harmonic sine waves at a fixed ratio. The level of each harmonic is as shown on the right. When fundamental content is 1, the content of n th harmonic is $1/n$.	
	 Square	The square wave contains a fundamental sine wave and its odd numbered harmonics at a fixed ratio. The level of each harmonic is the same as sawtooth wave: the content of n th harmonic is $1/n$; except that there are no even numbered harmonics.	
	 Pulse	With pulse wave, the harmonic content greatly varies depending on the pulse width. It is characterized by a lack of the n th harmonic series when the pulse width is $1/n$. The example on the left lacks 3rd, 6th, and 9th harmonics because the pulse width is $1/3$ (33%).	
	Square wave one octave lower than the DCO's ()		

Pulse Width

► Manual PWM

PWM MODE SWITCH ② → MAN

PULSE WIDTH ③ → Determines the Pulse width.

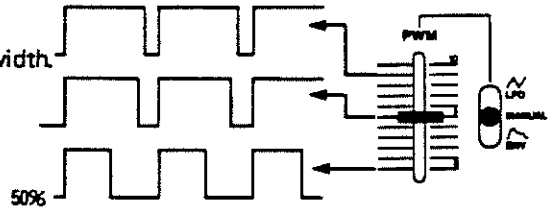

► PWM by LFO

PULSE MODE SWITCH ② → LFO

PULSE WIDTH MODULATION ③ →

Adjusts the intensity of the modulation.

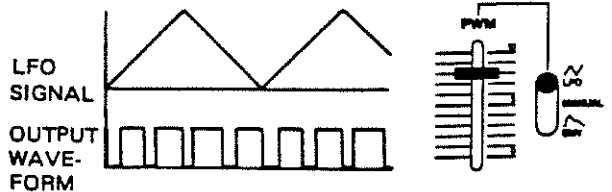

► PWM by ENV

PWM MODE SWITCH ② → ENV

PULSE WIDTH MODULATION ③ →

Adjusts the intensity of the modulation.

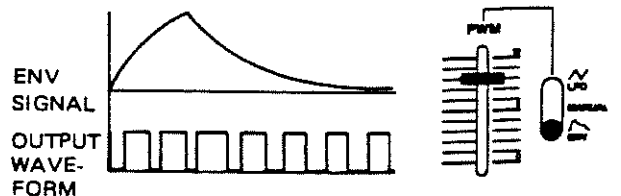

HPF

(High Pass Filter)

This filter lets the high frequency harmonics pass and cuts off the low frequency harmonics. As this filter is not voltage controlled, Cutoff Point is changed by only moving the knob.

① **FREQ • Cutoff Frequency knob**

This knob sets the Cutoff point of the HPF. In its lowest position, the DCO output passes the filter unchanged. As you raise the knob, Cutoff point will be boosted and only the higher harmonics are passed.

VCF

(Voltage Controlled Filter)

This filter changes the tone color by cutting off or emphasizing harmonics. This filter lets the low frequency harmonics pass and cuts off the high frequency harmonics, and is controlled by a voltage.

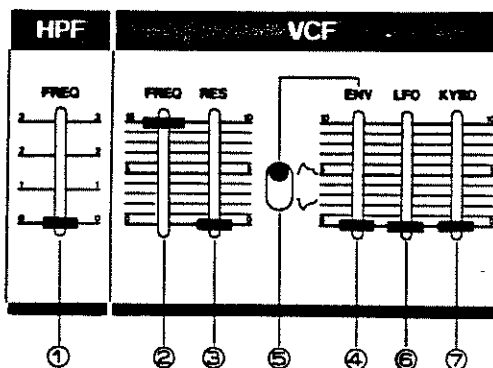
② **FREQ • Cutoff Frequency knob**

This knob is to change the Cutoff Point of the VCF. As you lower the knob, the frequency in the high pitch range will be cut off, and the sound will fade out when the waveform becomes nearest to a Sine Wave.

*  → Refer to P.15

③ **RES • Resonance knob**

This control emphasizes the Cutoff Point set by Cutoff Frequency knob 2. As you raise the knob, certain harmonics are emphasized and the created sound will become more unusual more electronic in nature. If you alter the Cutoff Frequency knob while the Resonance knob is set to a high level, you can create a type of sound that is attainable only from a synthesizer. If you raise the Resonance knob up to the maximum, the VCF will start Self Oscillation.

④ **ENV • Envelope Modulation knob**

When the Cutoff Point of the VCF is being modulated by the output of the Envelope Generator, this knob is used to adjust the intensity of the modulation. You can change the Cutoff Point of the VCF in each note with the ADSR pattern previously set. So the tone color of one note can be changed quite drastically.

⑤ **Polarity switch**

This is the selector switch for the polarity of the Envelope. When it is set at reverse polarity, the ADSR pattern will be reversed and the tone color alteration will be the other way round.

* This often means the Cutoff Frequency of the VCF (HPF) will need to be set higher.

⑥ **LFO • LFO Modulation knob**

When the Cutoff Point of the VCF is being modulated by the output CV of the LFO, this knob adjusts the depth of the growl or wah effects.

⑦ **KYBD • Key follow knob**

When the Cutoff Point is being controlled by the KYBD-CV (Keyboard control voltage), this knob adjusts the level of the KYBD-CV. It prevents any inconsistency in the harmonic content caused by pitch alteration. Consequently this knob is usually set to the maximum on such a long keyboard, but can be set to your taste.

▶ **NOTE**

- * The Self-oscillation of the VCF does not guarantee an accurate pitch. Therefore, you cannot expect a correct scale when playing the keyboard.
- * If using the VCF Self-oscillation as a sound source, its pitch may turn out unstable. In such a case, move the position of the FREQ knob until you get a stable pitch. (If you store it into memory and use it later, its pitch will be stable.)

Cutoff Frequency

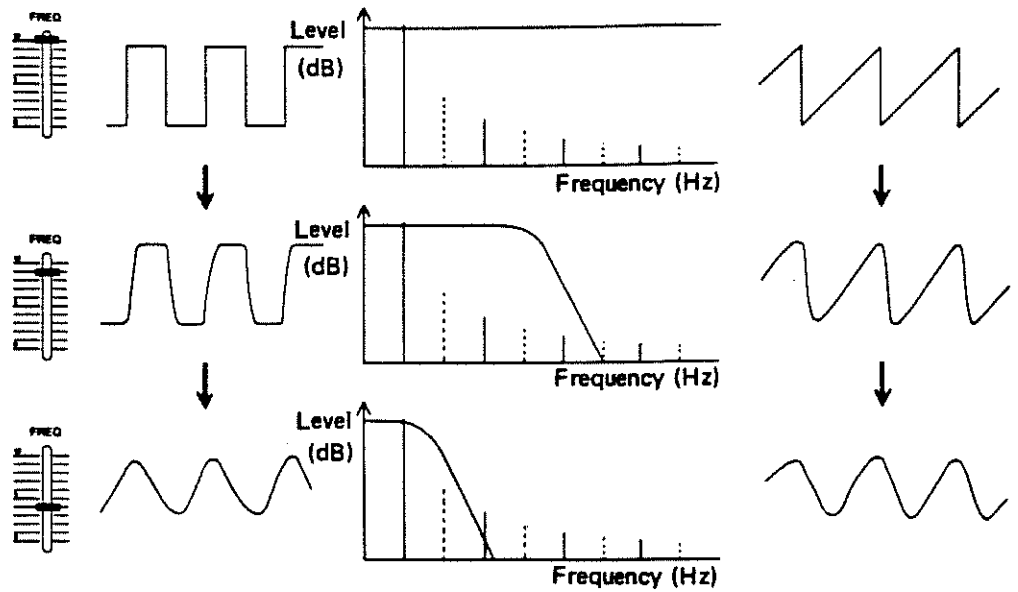

Resonance

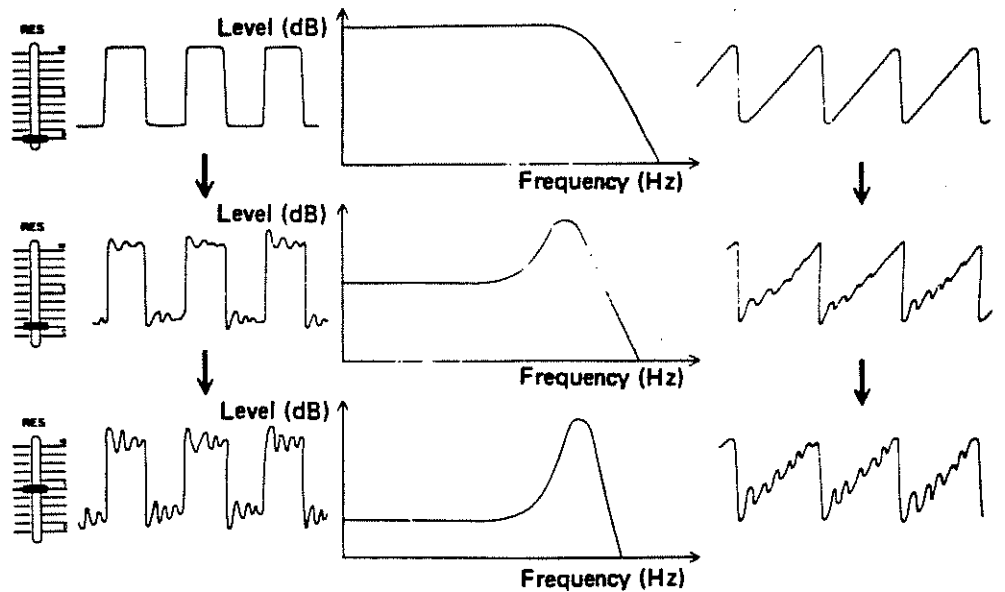

ENV Modulation

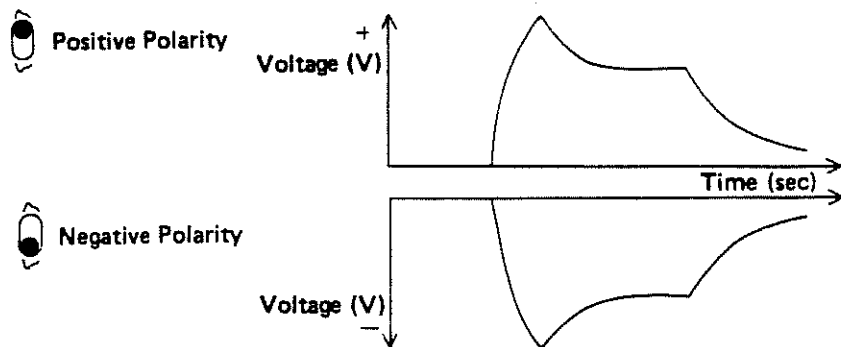

► NOTE

When modulating the VCF using the Envelope, set the knob ② to a fairly low level in case of positive polarity, and set it to a fairly high level in case of negative. Otherwise there will be little effect.

VCA

(Voltage Controlled Amplifier)

This is to control the volume (amplitude) of the sound, and is normally controlled by the output voltage from the Envelope Generator.

① Control Signal Selector switch

This switch enables you to select whether to control the VCA by the signal from the Envelope Generator or by the Gate signal.

② VCA level knob

This adjust the depth of the ENV modulation. (the amount of the ENV signal)

- This knob can be used to match the amplitudes (the volume sounds to your ears) of all the patch programs. This makes the live performance much more comfortable as there will be no volume difference realized between two different patches. While writing a patch into memory, adjust its level with this knob.
- When this knob is set too high, a sound distortion might occur, but this is not because of the trouble of the Juno-60.

ENV

(Envelope Generator)

This generates the Control Voltage applied to the VCF and the VCA, thereby controlling the volume and the tone color of each note. This output voltage is generated whenever you press a key.

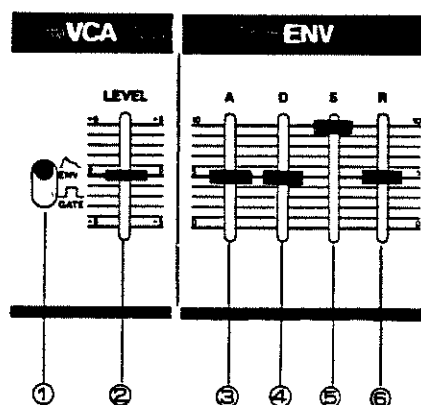

③ A (Attack Time) knob

This sets the time required for the voltage to reach its maximum from the moment the key is pressed down.

④ D (Decay Time) knob

This determines the time required for the voltage to drop from the maximum to the sustain level. When the sustain level is high, the Envelope curve does not change by adjusting the Decay Time.

⑤ S (Sustain Level) knob

This knob determines the Sustain Level to which the voltage falls at the end of the Decay Time.

⑥ R (Release Time) knob

This sets the time needed for the voltage to reach zero.

■ ENV OUTPUT (ADSR)

■ KYBD GATE

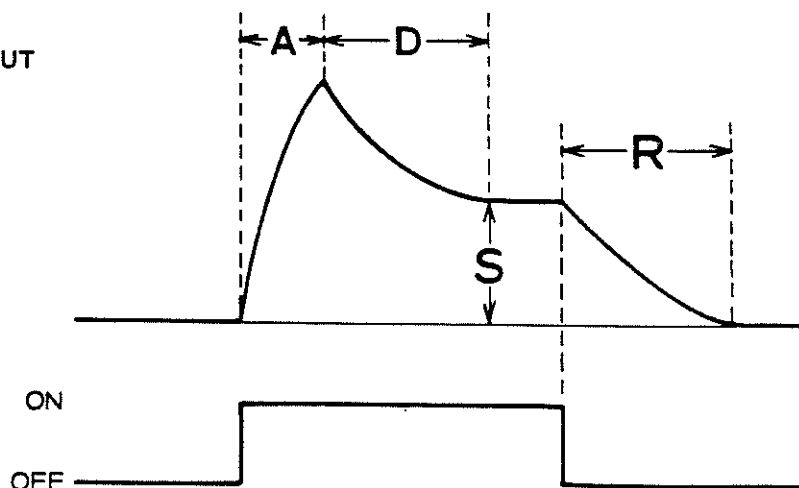

- The variation of each knob.

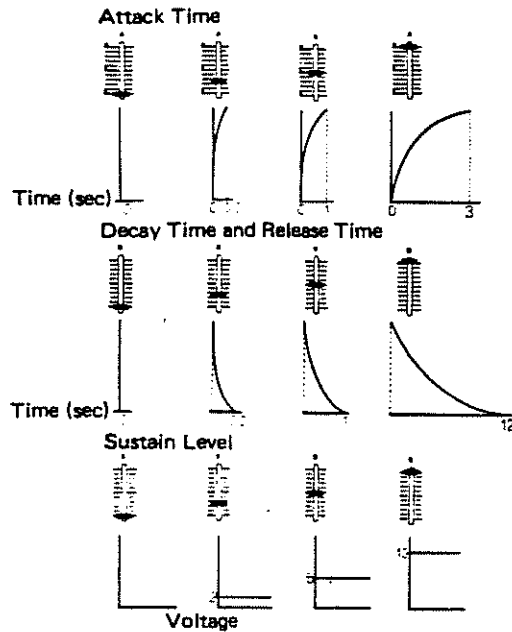

* In the figure shown above, the positions of the knobs are not meant to be exactly correct, so the knob position does not necessarily correspond with the time and the voltage.

- Setting of ADSR and Envelope Curve.

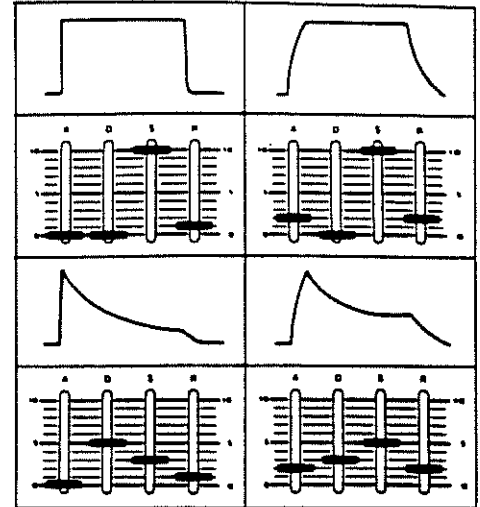

**When all of the ADSR sliders are set to zero, the waveform will be an extremely short Pulse wave, and only a short "click" is heard. Please be careful.

LFO
(Low Frequency Oscillator)

This oscillator generates only low frequency signal. It controls the VCO and the VCF to produce vibrato and growl effects.

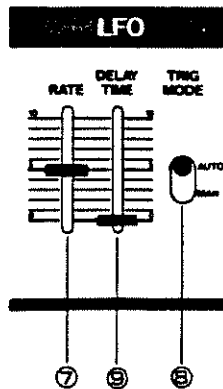

⑦ RATE knob

This adjusts the rate of LFO.

⑧ TRIG MODE • TRIGGER MODE switch

You can select whether to operate the LFO manually or automatically.

⑨ DELAY TIME knob

This sets the time needed for the LFO to start to function. The function varies depending on the position of the TRIGGER MODE switch ⑧.

TRIG MODE / DELAY TIME	AUTO 	MANUAL
 0	LFO always functions.	The LFO works while the LFO TRIGGER button is being pressed, and stops when the button is released.
 Other than 0	The LFO does not start to function until the Delay Time set with the DELAY TIME has passed. (*)	While the TRIGGER button is being pressed, the LFO amplitude becomes larger. When the delay time set previously has passed, it becomes normal amplitude.

* This Delay function works only in non-legato manner. So the Delay Time affects only the first key in a legato section.

KEYBOARD

The Roland Juno-60 has 5 octaves and 61 keys, but can be played as a 7 octave keyboard (as shown below) by using the TRANSPOSE switch. When the TRANSPOSE switch is set to Normal, the third C from the bottom

corresponds to the Middle C of a piano keyboard. So, if you wish to use the Juno-60 with the other keyboards, this knowledge will help you to align the Middle C of the two keyboards.

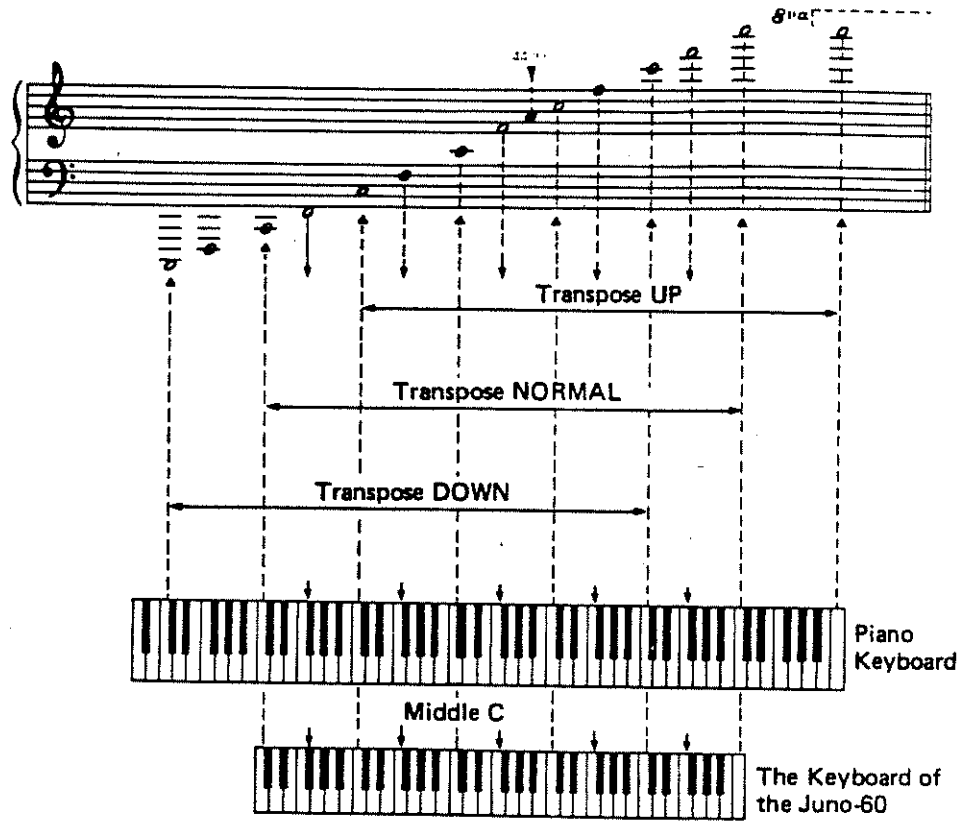

CONTROLLERS

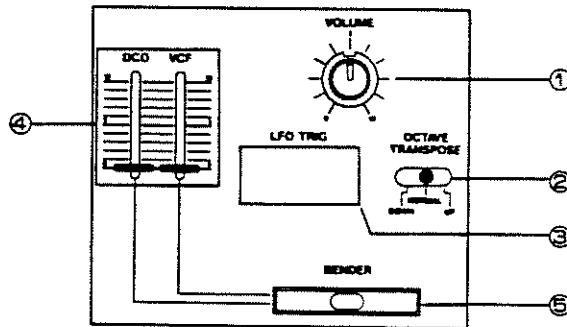

① VOLUME knob

② OCTAVE TRANSPOSE switch

By setting this switch to H or L, you can transpose up or down by one octave. How this switch is set can be written into memory.

③ LFO TRIG button

The LFO Modulation can be turned on and off with this button, if the LFO TRIGGER MODE switch is at (MANUAL) position. (Refer to P. 17)

④ Bend sens knobs

▲ DCO

When the pitch of the DCO is being controlled with the ⑤ BENDER, this knob adjusts the variable range of the pitch.

▲ VCF

When the Cutoff Point of the VCF is being controlled with the BENDER, this knob adjusts the variable range of the tone alteration.

⑤ BENDER lever

ARPEGGIO

The Juno-60 allows you an automatic Arpeggio play with the range of up to 3 octaves.

* Arpeggio Sample → P. 23

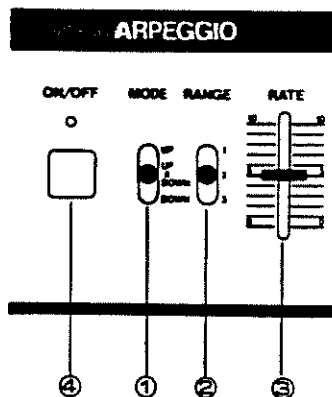

① MODE switch

This controls the movement of the patterns.

② RANGE switch

This determines the pitch range of Arpeggio.

③ RATE knob

This sets the speed of Arpeggio.

* (EXT CLOCK) → Refer to P. 21

▲ You can enjoy wide variation of Arpeggio by combining those three controls.

④ ON/OFF • Arpeggio switch

► NOTE

- An Arpeggio can only play while the keys are being held down unless you use the HOLD mode.
- Press each key of the chord at precisely the same moment, or the first pattern of the Arpeggio will be imperfect.
- The pitch range of the Arpeggio must be within the keyboard range. So if you set the range to 2 or 3 octaves and the Arpeggio pitch range exceeds the keyboard's range, the highest pitch range will be repeated.
- If you turn on the Arpeggio switch while holding the keys down, Arpeggio may fail to start properly. Turn on the Arpeggio switch before pressing the keys down.

RANGE MODE

• Arpeggio Patterns in case of

RANGE \ MODE	1 oct	2 oct	3 oct
UP			
UP/DOWN*			
DOWN**			

* Occasionally, the first octave may take a while to "settle in" if you use the DOWN mode.

** Also, in the Down mode, if you change from either of the other two modes, the last note of the previous mode will become the first note of the Down mode.

HOLD

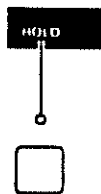

When this button is pressed, the sound remains even after you release the key. The level of the sound is controlled by the S (Sustain Level) in the Envelope Generator. Consequently you cannot hold a sound that has a Sustain level of zero.

Also, the HOLD function applies up to 6 keys at a time, and if more than 6 keys have been played, the last six keys will remain.

*  → Refer to P. 21

ARPEGGIO & HOLD

If you press the HOLD button while an Arpeggio is being played, it will continue to be played even after the keys are released. In this case, no matter how many keys are pressed, each time you press a new key, you will hear a new Arpeggio with a different pattern.

▲ NOTE

Turn the ARPEGGIO switch on before turning on the HOLD switch. If you turn on or off the ARPEGGIO switch with the HOLD on, the previous pattern may be played, which makes operation awkward.

KEY TRANSPOSE

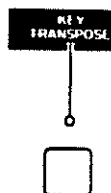

■ How to transpose

While holding the TRANSPOSE button down, press any key in any octave. If the indicator above lights up, transposition is completed and the Juno-60 will now play in the key of the chosen note.

- Normally C cannot be transposed; only the highest C can be transposed one octave up. (The indicator lights up.)

Transposition to any key is possible. By using the appropriate key, you can shift the pitch of the entire keyboard. Moreover you can play a piece with many #s and b's in the key of C major (A minor).

■ How to return to the normal key (C key)

While holding the TRANSPOSE button down, press any C note (except for the highest C), and the indicator will go out and the Juno-60 has returned to the normal condition (the key of C).

- * Key transposition is not possible while an Arpeggio is being played.

HOLD & KEY TRANSPOSE

The sound, sustained by the HOLD function, can be transposed as well. Hold the chord then transpose as shown above. Using the top octave, you can transpose the key up by one octave.

REMOTE CONTROLS

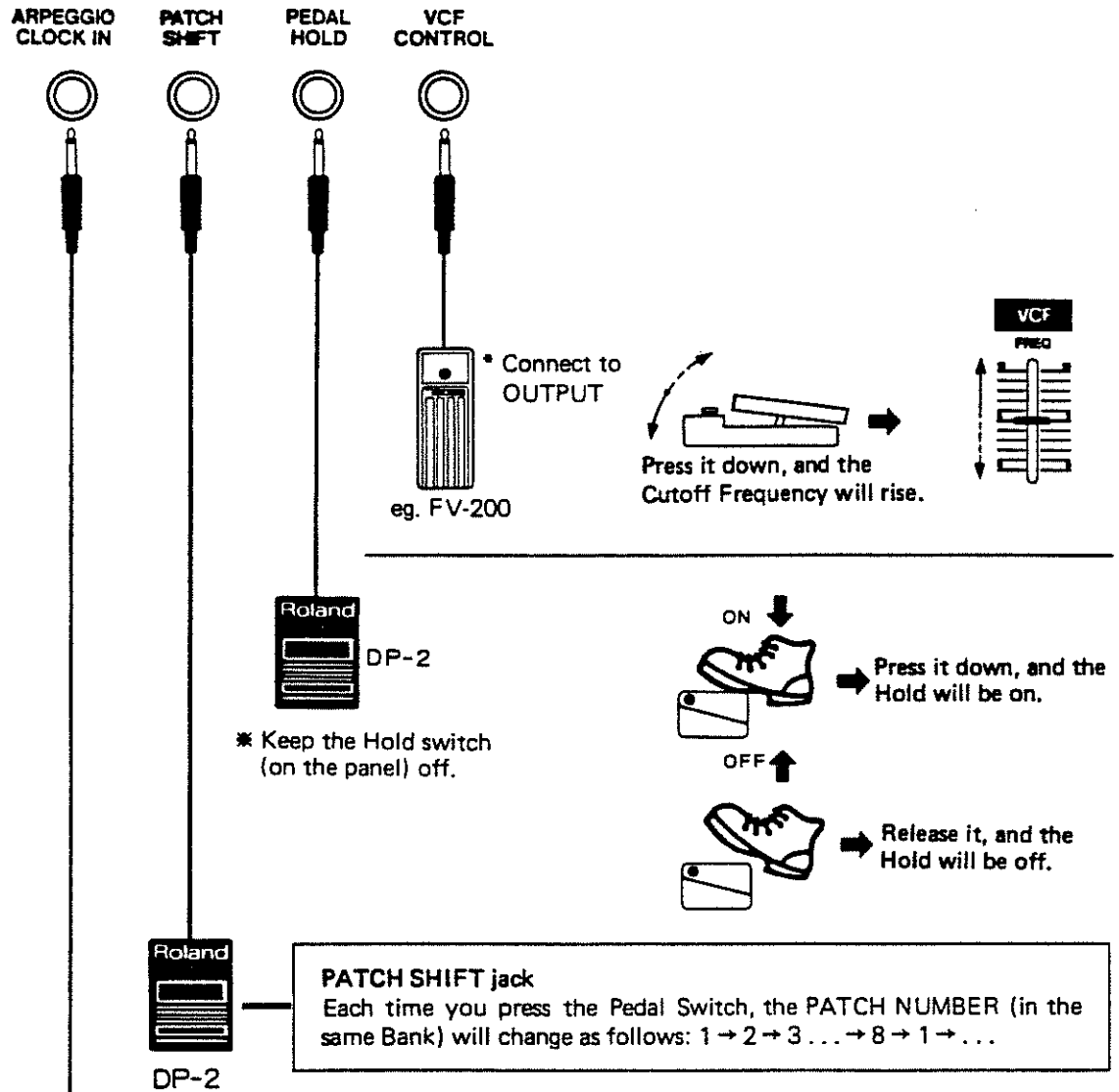

1 note per 1 pulse

RHYTHM MACHINE SEQUENCER etc.

* When it is connected to the ARPEGGIO CLOCK IN, the Arpeggio Rate knob on the panel does not function.

- CR-8000, 5000 TRIGGER OUT
- DR-55 DCB, CSQ*
- TR-606, 808 TRIGGER OUT*
- TB-303 } GATE OUT*
- CSQ-600 } GATE OUT*
- MC-4 GATE OUT*
MPX OUT*

* You can play Arpeggio with many kinds of patterns.

DCB (Digital Communication Bus)
The DCB is an interface system that converts the CV or the GATE signal into a digital signal for the communication between the Juno-60 and the external unit (which also includes the DCB).
By using the OP-8 CV-interface, you can drive the Juno-60 with the MC-4 micro-composer.
* Refer to the OP-8 Owner's Manual for the details.
▶ NOTE
Please do not connect the Juno-60 to any other device but the OP-8.

CHORUS

CHORUS

OFF I II
o o









This gives spaciousness and richness to the sound. The effect becomes stronger from left to right, that is, II is stronger than I. Use the stereo output (2ch) to obtain the best effect.

Optional Effect Units

An echo chamber is most commonly used of all the effect units. It has such a strong effect that it is often said to be indispensable when using synthesizers.

Effect units such as a Phaser or a Flanger have the ability to add unique changes to the

sound, and it is effective to use them with Echo Chamber. A Phaser gives an effect which can change the noise to a jet sound. A Flanger has an effect similar to a Phaser's, but stronger, and can give power to a synthesizer bass sound.

Echo Chamber		SRE-555 RE-501 RE-201 RE-150
Delay Machine		DC-30 DM-100
Digital Delay		SDE-2000
Phaser/Flanger		SPH-323, PH-1R SBF-325, BF-2
Equalizer		SEQ-331, SEQ-315 GE-10, GE-7
Reverb		RX-100
Chorus		CE-2, CE-3 SDD-320

When using Arpeggio as an accompaniment, adopt a pattern that is completed within one measure. Select the appropriate range and mode according to the number of notes included in the chord, and beats in the bar.

* The SAMPLE SCORES show the examples of when you press each note of the chord simultaneously. If there is a time gap in pressing each note, the scores will not be the same.

1 Three note Arpeggio (1 oct. UP/DOWN)

2 Three note Arpeggio (2 oct. UP)

3 Three note Arpeggio (3 oct. UP/DOWN)

4 Four note Arpeggio (1 oct. UP/DOWN)

5 Four note Arpeggio (2 oct. UP)

6 Five note Arpeggio (1 oct. UP/DOWN)

7 Arpeggio with a Bass note (1)

- Press one Bass note with the left hand and three notes of the chord with the right hand.

8 Arpeggio with a Bass note (2)

- Press one Bass note with the left hand and three notes of the chord with the right hand.

9 Special use of Arpeggio Mode (Bass Pattern)

10 Special use of Arpeggio Mode (Tremolo I, II)

Tremolo I

- Play a single note and adjust the speed of tremolo with the RATE control. Lower the Sustain Level and shorten the Decay Time. Organ like sound is obtained by adjusting ENV.

Tremolo II



- Tremolo with xylophone like octave sound.

56 different patches are pre-programmed in the Juno-60, and each setting example is shown in the Patch Program Data book. Also, the example patches shown below are recorded in the side B of the supplied cassette tape.

	patch-1	patch-2	patch-3	patch-4	patch-5	patch-6	patch-7	patch-8
bank 1	1 1 Strings 1	1 2 Strings 2	1 3 Strings 3	1 4 Organ 1	1 5 Organ 2	1 6 Organ 3	1 7 Brass	1 8 Phase Brass
bank 2	2 1 Piano 1	2 2 Piano 2	2 3 Celesta	2 4 Mellow Piano	2 5 Harpichord 1	2 6 Harpichord 2	2 7 Guitar	2 8 Synthesizer Harp
bank 3	3 1 Bass 1	3 2 Bass 2	3 3 Clavichord 1	3 4 Clavichord 2	3 5 Pizzicato Sound 1	3 6 Pizzicato Sound 2	3 7 Xylophone	3 8 Glockenspiel
bank 4	4 1 Violine	4 2 Trumpet	4 3 Horn	4 4 Tube	4 5 Flute	4 6 Clarinet	4 7 Oboe	4 8 English Horn
bank 5	5 1 Funny Cat	5 2 Wah Brass	5 3 Phase Combination	5 4 Reed 1	5 5 Popcorn	5 6 Reed 2	5 7 Reed 3	5 8 PWM Chorus
bank 6	6 1 Synthesizer Organ	6 2 Effect Sound 1	6 3 Effect Sound 2	6 4 Space Harp	6 5 Funk	6 6 Space Sound 1	6 7 Mysterious Invention	6 8 Space Sound 2
bank 7	7 1 Percussive Sound 1	7 2 Percussive Sound 2	7 3 Whistle	7 4 Effect Sound 3	7 5 UFO	7 6 Space Sound 3	7 7 Surf	7 8 Synthesizer Drum

- The tone color can differ drastically due to a slight change of the knob positions (particularly the FREQ knob). It also varies depending on the amplifier and the speaker used. Please amend the setting while actually playing the keyboard.
- If the pitch range of the sample sound is narrow, you should play within the range which allows that sound to represent its feature properly.
- When you select the patch of the single tone musical instrument, play in a non-legato manner. Also, it may prove interesting to use the Bender.
- Bank 7(71 to 78) includes the patches whose sound sources are VCF self-oscillation. Therefore, you need to adjust their pitches with the FREQ knob in VCF to obtain accurate pitches.

REMARKS

TRANSPOSE switch	D = DOWN N = NORMAL U = UP	* Please note that the settings shown include the knob positions which are irrelevant to the sound.
LFO TRIG Mode selector switch	A = AUTO M = MANUAL	
DCO PWM mode selector switch	L = LFO M = MANUAL E = ENV	
VCF ENV Polarity switch	N = NORMAL () I = INVERTED ()	
VCA E/G selector switch	E = ENV G = GATE	

		LFO			DCO					HPF	VCF			VCA	ENV			CHORUS											
		1	2	3	4	5	6	7	8	9	10	11	12	13	14	15	16	17	18	19	20	21	22	23	24	25	26	27	28
11	N	6	0	A	0	0	L	*		0	0	0	7	0	N	0	0	10	E	0	4	0	10	4.5	*				
12	N	4	0	A	0	6	L	*	*		0	0	0	7	0	N	0	0	10	E	-2	4	0	10	4.5	*			
13	N	3	8	M	0	7	L	*	*	*	10	0	0	5	0	N	0	0	10	E	-2	3	0	10	6	*			
14	N	2	8	A	0	5	M	*		*	10	0	0	4	6	N	4.5	0	10	G	0	0	0	0	0	0	*		
15	N	5	4	A	0	5.5	L	*		*	8	0	0	3.5	5.5	N	4	0	10	G	0	0	1	0	1	*			
16	U	5	4	A	0	5.5	L	*		*	8	0	0	3.5	5.5	N	3.5	0	10	G	0	0	1	0	1	*			
17	N	5	6.5	A	1.5	0	M	*			0	0	0	0	0	N	8.5	0	4	E	+2	2.5	4	6	2	*			
18	N	6	0	A	0	10	E	*	*		10	0	0	3	1	N	5.5	0	10	G	-1	2	4	4	3	*			
21	N	6	3	M	4.5	6	M	*			0	0	0	1	0	N	7	0	4	E	+2	0	8	1.5	3	*			
22	U	4	0	A	0	4	M	*		*	4.5	0	0	3.5	0	N	2.5	2	8	E	+3	0	7.5	0	3.5	*			
23	N	3.5	6	A	0	5	E	*	*		10	0	1	3.5	8	N	0	0	10	E	+1	0	6.5	2	5.5	*			
24	N	5	0	M	0	5	M	*			10	0	0	3	0	N	2.5	1	9	E	+2	1	7.5	2	8.5	*			
25	U	5	4	A	0	3	M	*		*	7	0	1	3	0	N	5	0	7	E	-1	0	6	3.5	2.5	*			
26	U	5.5	6	A	0	2	M	*		*	8.5	0	1	5	2.5	N	3	0	10	E	0	0	5	1.5	5	*			
27	N	6	6	A	0	6	M	*			10	0	2	3	0	N	4.5	1.5	5	E	+4	0	5.5	3.5	6.5	*			
28	N	3	8	M	0	0	M	*			10	0	0	3	0	N	5	0	8	E	+1	0	5.5	3	5	*			

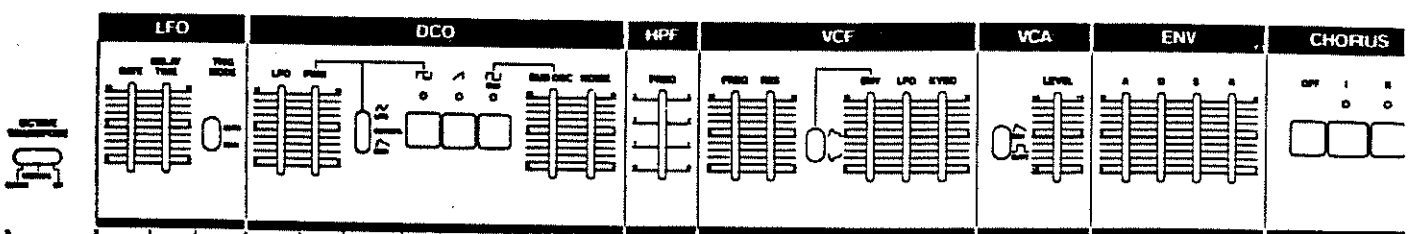

		LFO			DCO					MPF		VCF				VCA		ENV				CHORUS				
		1	2	3	4	5	6	7	8	9	10	11	12	13	14	15	16	17	18	19	20	21	22			
31	D	5	6	A	0	5	M	*	*	*	3	0	0	3	2.5	N	3.5	0	0	G	0	0	4	1	2.5	*
32	D	5	6	A	0	5	M	*	*		3	0	0	3	5	N	4.5	0	5	G	-1	0	3	3.5	2.5	*
33	D	6	2.5	M	4	8	M	*			0	0	0	0	3	N	8	0	6	E	+2	0	5	3.5	1.5	*
34	D	1	0	A	0	8	M	*			10	0	1	5.5	7	N	2	2.5	7	E	+5	0	4.5	2	2	*
35	N	5	6	A	0	3.5	M	*			3	0	0	4.5	3	N	3	3	10	E	+3	0	2	3.5	5.5	*
36	U	5	6	A	0	2	M	*	*		3	0	0	5	3	N	3	0	10	E	+1	0	3	3	4	
37	U	5	0	A	0	5	M		*		10	0	1	4	5	N	3	0	6	E	+5	0	3.5	0	3.5	*
38	U	5	0	A	0	0	M	*			0	0	1	4.5	5	N	3	0	6	E	+4	0	3	2.5	5	*
41	N	6	6	A	2	0	L	*			0	0	1	6.5	0	N	0	0	10	E	+2	4	0	10	4	*
42	N	2.5	6.5	A	1.5	0	M	*			0	0	0	0	0	N	8.5	0	4	E	+2	2.5	4	6	2	*
43	N	2.5	7	A	0	0	M	*			0	0	0	2	0	N	5.5	2	4	E	+2	4	5	6	3	*
44	D	2.5	7	A	1.5	0	M	*			0	0	0	1.5	0	N	6	0	4	E	+5	3	4	4	3	*
45	U	5.5	5	A	0	0	M	*			0	1.5	1	5	0	N	0	2	6	E	+5	2	6	5	2.5	*
46	N	5	6.5	A	1.5	0	M	*			0	0	1	5	3	N	2.5	0	6	E	+1	2.5	6	6	2.5	*
47	N	5.5	6.5	A	1.5	6.5	M	*			0	0	3	4.5	5	N	2.5	0	5	E	+5	2	6	6	2.5	*
48	D	5	7	A	2	6.5	M	*			0	0	3	5	7	N	0	1.5	5	E	+5	2	6	6	2.5	*

	LFO			DCO					HPF		VCF			VCA		ENV				CHORUS						
	Rate	Waveform	Depth	Frequency	Amplitude	Phase	Modulation	Filter	Resonance	Cutoff	Q	Envelope	Attack	Decay	Sustain	Release	Rate	Depth	Rate	Depth	Rate	Depth				
51	N	6	2	M	3	0	M	*		0	0	1	1.5	7.5	N	5	2	5	E	+3	2.5	4	10	1	*	
52	N	6	2	M	3	0	M	*		0	0	0	3	7	N	4.5	0	6	G	+2	3	3	4	2	*	
53	N	6	2	M	0	8	M	*	*		0	0	0	6	2	N	3	0	2	E	-2	0	7	2	2	*
54	N	6	2	M	4	0	M	*		0	0	0	1	6	N	7	0	5	G	+1	0	8.5	5	1	*	
55	U	0	0	A	0	0	M			*	10	0	1	2.5	2	N	5.5	0	10	E	+3	0	3	2	0	*
56	U	3	8	M	0	0	M			*	10	0	0	2	0	N	6	0	8	E	0	0	5.5	3	6	*
57	U	6	2	M	2	5	M			*	10	0	0	3	2	N	3	0	10	E	+1	2.5	0	10	2	*
58	N	3	0	M	0	5	L	*		*	10	0	0	8	0	N	0	0	10	E	-3	3	0	10	4	*
61	N	4.5	6	A	0	6.5	M	*		*	7.5	0	0	2.5	0	N	5	2	7	G	0	0	2	5	2.5	*
62	U	4.5	6	A	1.5	10	M	*	*	*	7	0	0	6.5	0	I	4.5	0	7	E	+2	0	5	0	5.5	*
63	N	5.5	9	A	0	3	L	*	*	*	6.5	0	0	6.5	3	I	4	0	1	G	-1	6.5	5.5	2	6.5	*
64	N	5.5	0	A	2	0	E	*			0	0	0	6.5	5	N	5.5	0	10	E	+1	0	8	8	9	*
65	N	3	2.5	A	0	6	M	*	*	*	10	0	0	7.5	6	I	5	0	4.5	G	-3	6	5	0	0	*
66	N	6	7	A	2	4.5	M	*		*	10	0	0	6.5	7	I	5.5	0	10	G	-2	0	8	0	3	*
67	N	6	8	A	2	8	E	*	*		10	0	0	8	7	I	6	2.5	0	E	0	0	10	0	10	*
68	N	3	3	A	0	6	M	*	*		8	0	0	2	8.5	N	6	0	10	E	-3	10	10	10	10	*

10

	LFO				DCO				MPF	VCF				VCA	ENV				CHORUS						
	1	2	3	4	5	6	7	8	9	10	11	12	13	14	15	16	17	18	19	20					
71	U	0	0	A	0	0	E			0	10	1	4	10	N	1.5	0	10	E	+5	0	3	0	4	*
72	N	0	0	A	0	0	E			0	0	1	5	10	I	3.5	0	10	E	+5	0	3	0	4	*
73	U	5.5	5	A	0	0	M			0	2	1	3.5	10	N	1.5	2	10	E	+3	3	0	10	1	*
74	N	5.5	4	A	0	0	E			0	0	1	3.5	10	N	0	2	10	E	+5	0	4	5.5	7	*
75	U	6	0	A	0	0	M			0	2	0	0	10	N	7	4	10	E	-1	0	6	10	8	*
76	U	6	0	A	0	0	M			0	2	0	5	10	I	4	0	10	E	0	0	10	0	8	*
77	N	0	0	A	0	0	E			10	10	0	6	0	N	0	6	10	E	+4	0	4	10	8	*
78	N	0	0	M	0	0	E			0	0	0	2	10	N	4	0	10	E	+1	0	5	0	6	*

	patch-1	patch-2	patch-3	patch-4	patch-5	patch-6	patch-7	patch-8
bank 1	11	12	13	14	15	16	17	18
bank 2	21	22	23	24	25	26	27	28
bank 3	31	32	33	34	35	36	37	38
bank 4	41	42	43	44	45	46	47	48
bank 5	51	52	53	54	55	56	57	58
bank 6	61	62	63	64	65	66	67	68
bank 7	71	72	73	74	75	76	77	78

The diagram illustrates the signal flow through various stages of a synthesizer:

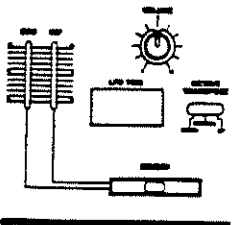
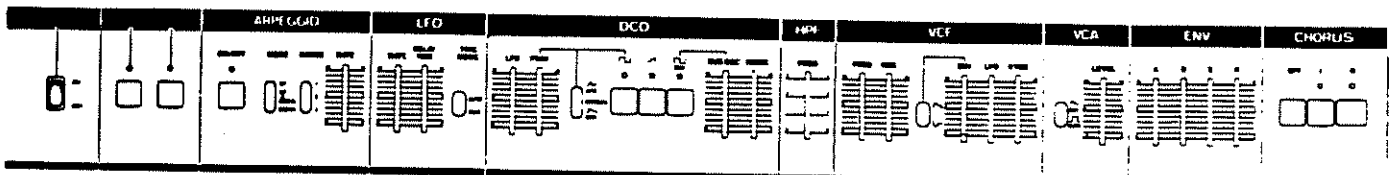
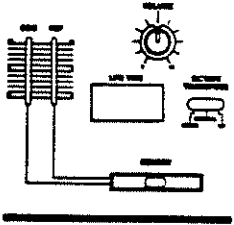
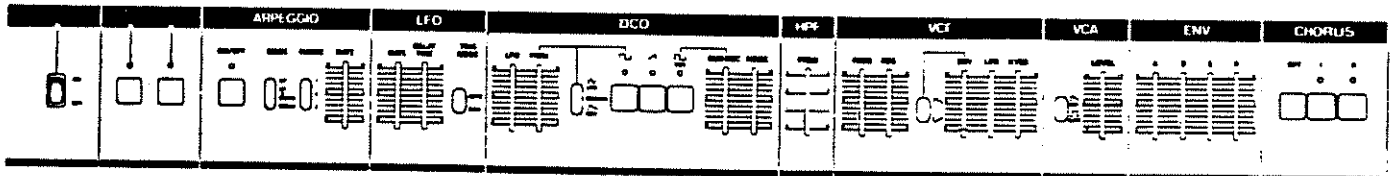
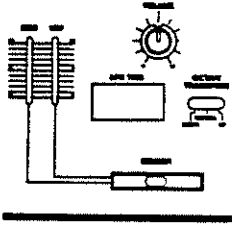
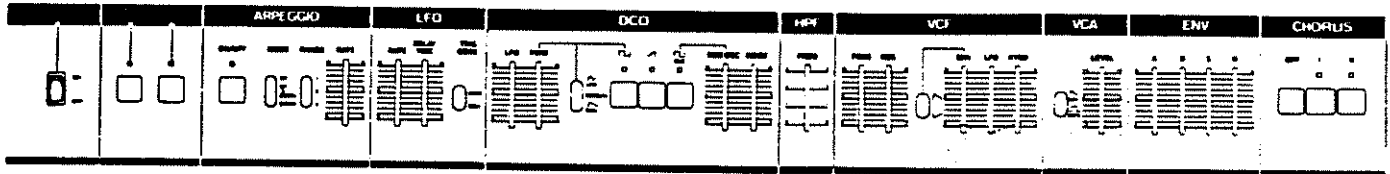
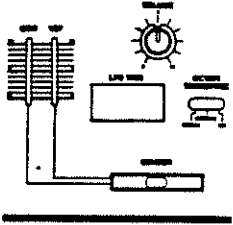
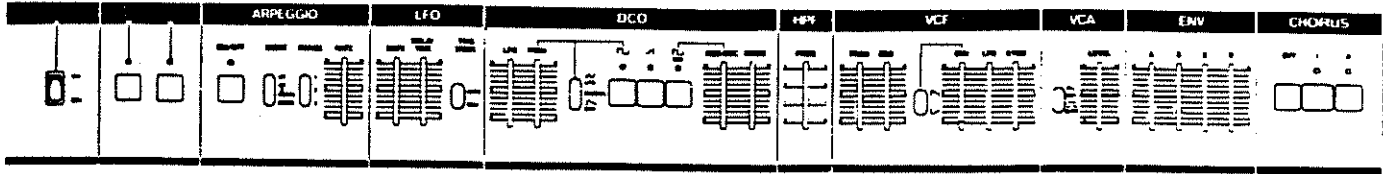

- LFO:** Includes a waveform generator and a rate control slider.
- DCO:** Contains a frequency oscillator, a phase control, and a detune control.
- HPF:** A high-pass filter section with a resonance control.
- VCF:** A variable frequency filter with resonance, envelope, and level controls.
- VCA:** A voltage-controlled amplifier with a level control.
- ENV:** An envelope generator with attack, decay, sustain, and release controls.
- CHORUS:** A chorus effect section with depth and rate controls.

Parameter	Value
LFO Rate	1
DCO Freq	1712
DCO Phase	2
DCO Detune	1
HPF Res	12
VCF Res	1
VCF Env	5
VCF Level	1
VCA Level	1
ENV Attack	1
ENV Decay	1
ENV Sustain	1
ENV Release	1
CHORUS Depth	1
CHORUS Rate	1

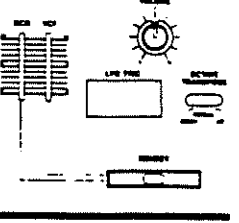
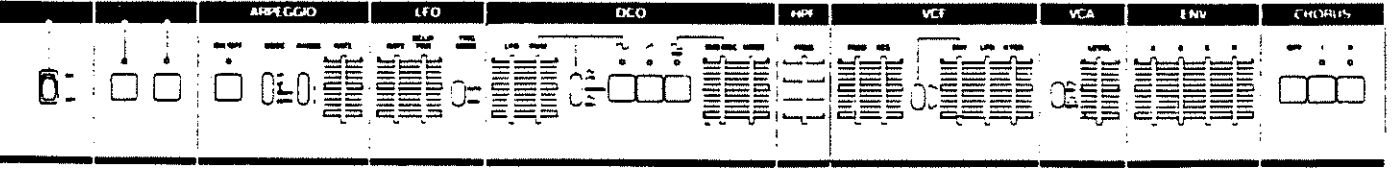
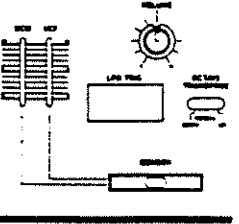
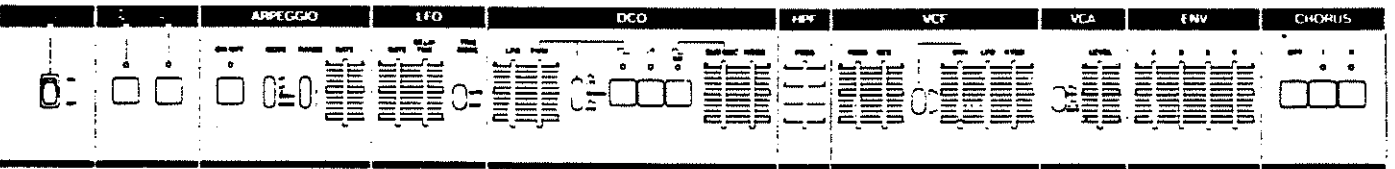
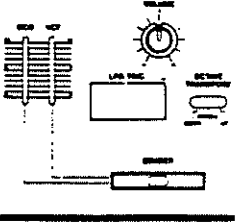
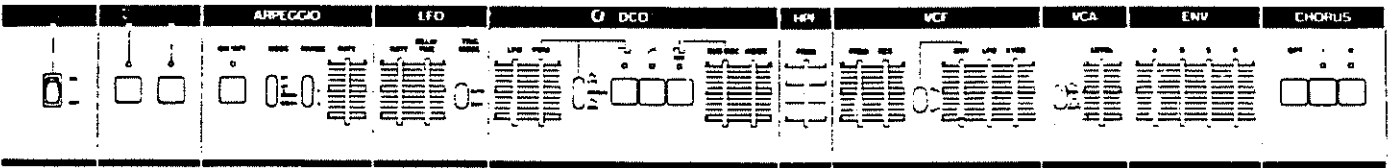
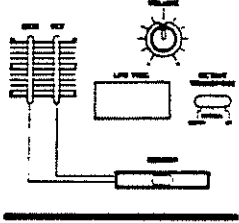
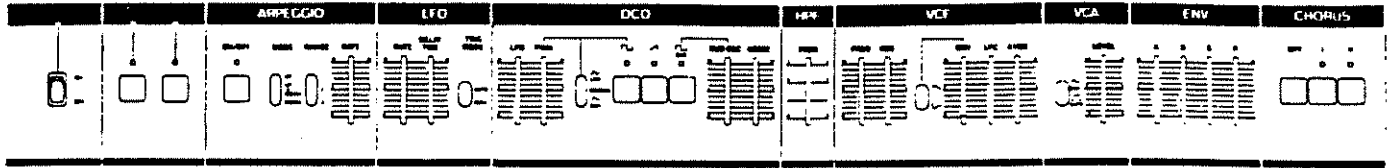



● **JUNO-60** ● **6 Voice Programmable Polyphonic Synthesizer**

Keyboard	61 keys, 5 octaves
DCO	LFO Modulation knob Pulse Width Modulation knob PWM Mode switch (ENV/MANUAL/LFO) Pulse Wave (ON/OFF) & indicator Sawtooth (ON/OFF) & indicator Sub Oscillator (ON/OFF) & indicator Sub Oscillator Level knob NOISE Level knob
HPF	Cutoff Frequency knob
VCF	Cutoff Frequency knob Resonance knob (0 ~ Self Oscillation) ENV Modulation knob Key Follow knob (0 ~ 100%)
VCA	Control Signal Selector switch (ENV  /GATE ) VCA Level knob
ENV	Attack Time knob (1ms ~ 3s) Decay Time knob (2ms ~ 12s) Sustain Level knob (0 ~ 100%) Release Time knob (2ms ~ 12s)
LFO	RATE knob (0.3Hz ~ 20Hz) TRIGGER MODE switch (AUTO/MAN) DELAY TIME knob (0 ~ 2s)
Controllers	VOLUME knob OCTAVE TRANSPOSE switch (DOWN/NORMAL/UP) LFO Trigger button Bend Sens (DCO) Bend Sens (VCF) BENDER lever
Arpeggio	MODE switch (UP/UP & DOWN/DOWN) RANGE switch (1/2/3) RATE knob (1.5Hz ~ 50Hz) ARPEGGIO switch (ON/OFF) & indicator
HOLD	HOLD switch (ON/OFF) & indicator
Key transpose	KEY TRANSPOSE button & indicator
MEMORY	PATCH NUMBER buttons (1 ~ 8) BANK buttons (1 ~ 5) MANUAL button WRITE button SAVE button & indicator VERIFY button & indicator LOAD button & indicator Program Number Display window
Power	POWER switch & indicator

Rear panel	OUTPUT jacks (mono, stereo) Output Level selector switch (L: -30dBm/M: -15dBm/H: 0dBm) PHONES jack (stereo) VCF CONTROL jack (FV-200) PEDAL HOLD jack (DP-2) PATCH SHIFT jack (DP-2) ARPEGGIO CLOCK Input jack (1 step/1 pulse = +2.5V or more) SAVE jack LOAD jack MEMORY PROTECT switch DCB (Digital Communication Bus) TUNE adjust knob (50 cent)
Dimensions	1060(W) x 378(D) x 113(H) mm/41-3/4(W) x 14-7/8(D) x 4-7/16(H) inch
Weight	12 kg/26 lb. 7 oz.
Consumption	30 W
Accessories	2.5 m connection cables 2

* Specifications are subject to change without notice.

Options

- Headphones
RH-10



- Foot Volume
FV-200

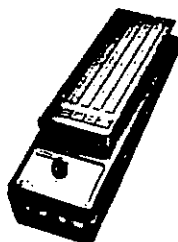

- Pedal Switch
DP-2



- CV Interface
OP-8

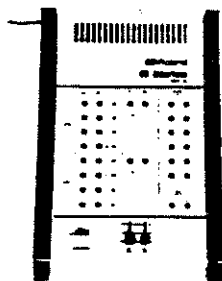

- Carrying Case
CB-JUNO

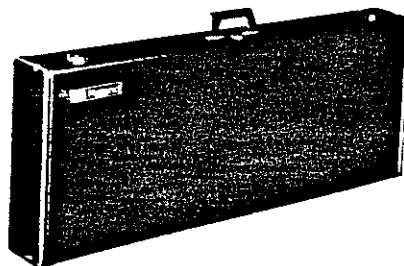

- Stand
KS-2

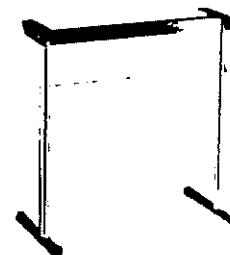

Roland®

10673

UPC 10673



10991

Roland®